



# ART EXPERTISE

PORTFOLIO



# AGENDA

- 1. Corporate facts.....3
- 2. Last projects we worked on.....4
- 3. AAA art expertise.....5
  - 3.1. Weapons.....6
  - 3.2. Characters.....34
  - 3.3. Props.....50
- 4. Casual art expertise.....64
  - 4.1. Characters.....65
  - 4.2. Illustrations.....72
    - 4.2. UI/UX.....76
  - 4.3. Environment.....82
  - 4.4. Props.....85
- 5. Client reviews.....93
- 6. Contact us.....94



# CORPORATE FACTS

Kevuru Games is a leading European Art Production and Game Development firm creating transformational entertainment projects for global clients.

We're proud to partner with TOP Tier companies in the gaming industry.

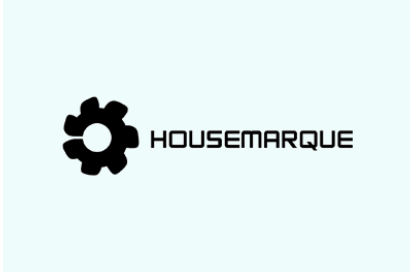

# LAST PROJECTS WE'VE WORKED ON

Our mission is to go an extra mile to deliver high-quality products with WOW effects and ensure maximum satisfaction for our customers. We have more than 50 partners worldwide and our clients are among of the top 10 world digital entertainment publishers.



**LUCASFILM**  
Ltd



**W**agyu  
Games



**BYTRO**



**Birdly**  
by SOMNIACS

# AAA ART EXPERTISE



### AR-15

Tris – 81114  
 UV set – 4 (4096x4096)  
 Estimation – 43 days



**AR-15**  
Render



**AR-15**  
Render





# AR-15

Bake and Texturing



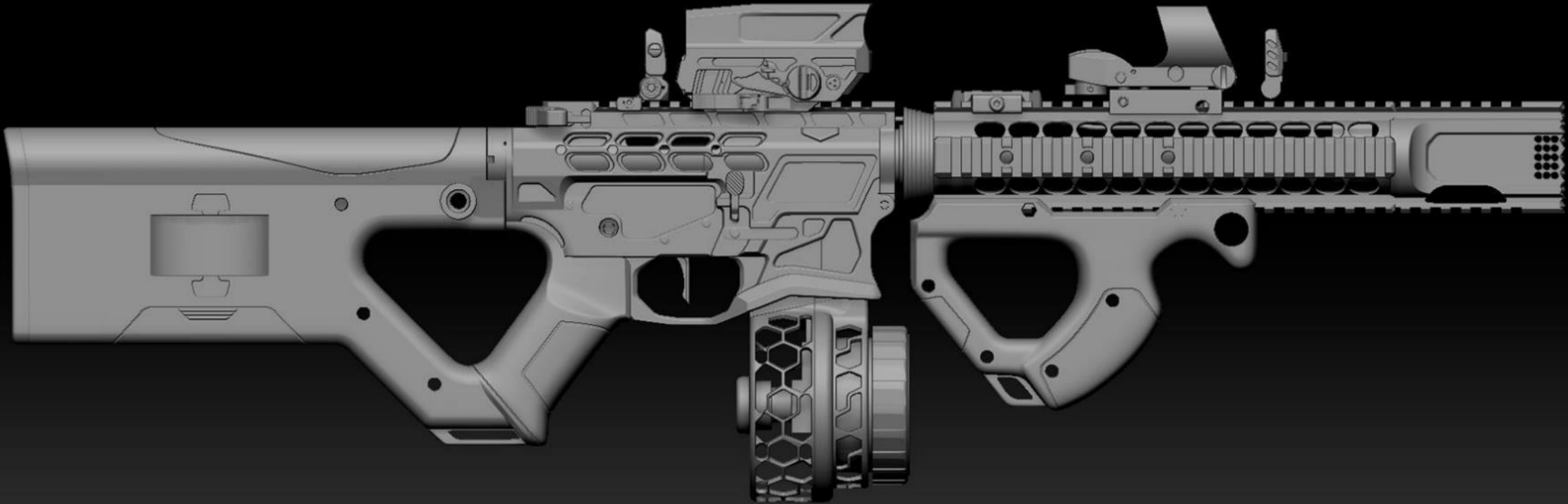

**AR-15**  
High Poly

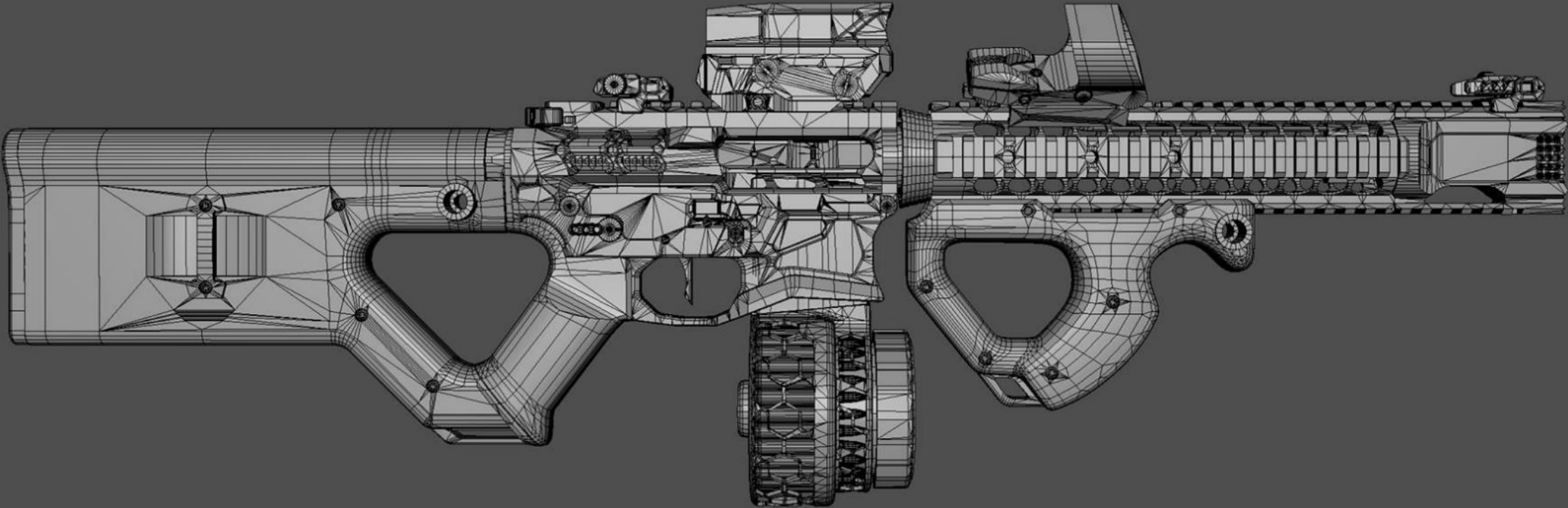

**AR-15**  
Low Poly

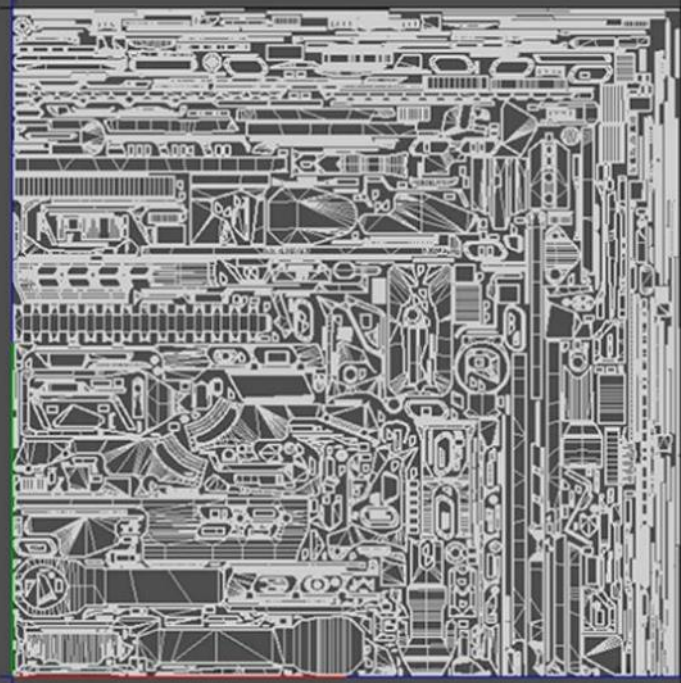
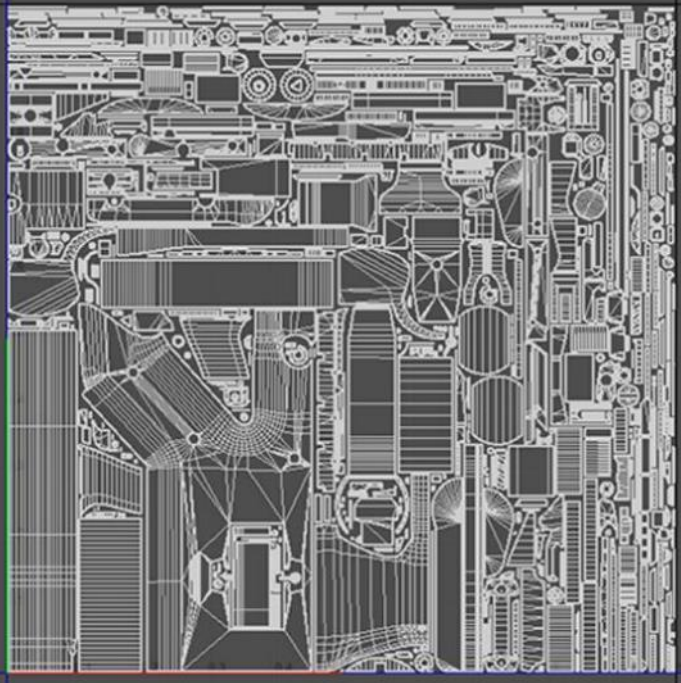
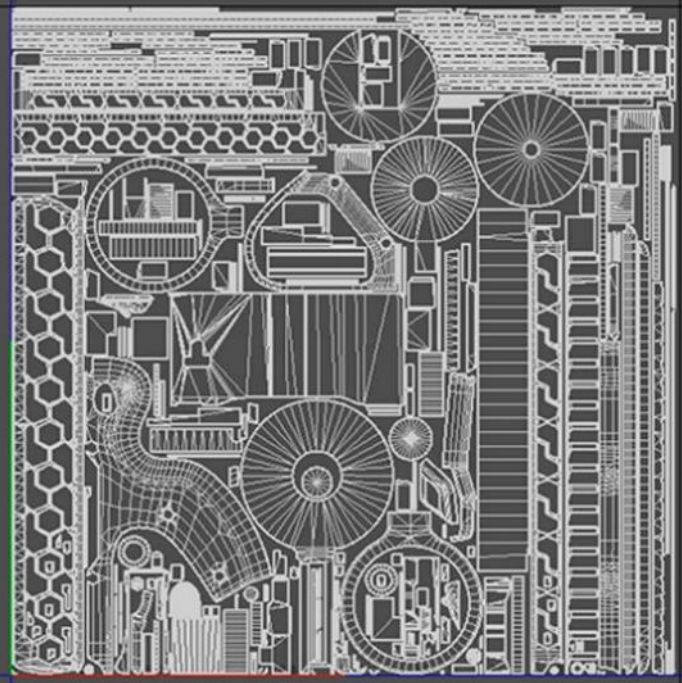

**AR-15**  
UV



## Galil ace gen 2

Tris - 80869

UV set – 3 (4096x4096)

Estimation – 38 days



## Galil ace gen 2

Render



# Galil ace gen 2

Render



# Galil ace gen 2

Bake and Texturing





**Galil ace gen 2**  
High Poly



# Galil ace gen 2

Low Poly



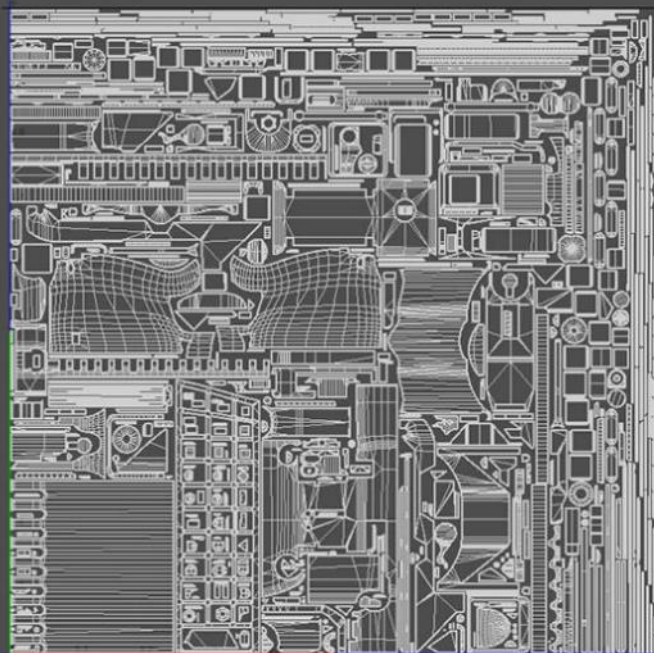
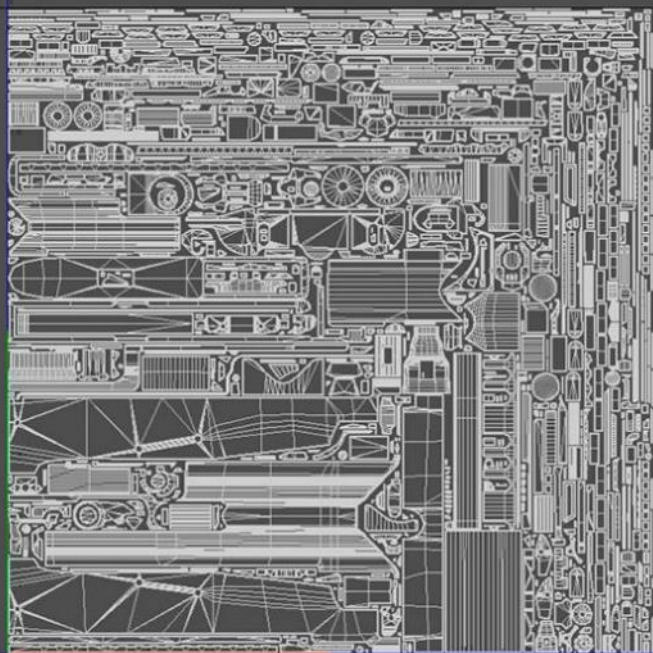
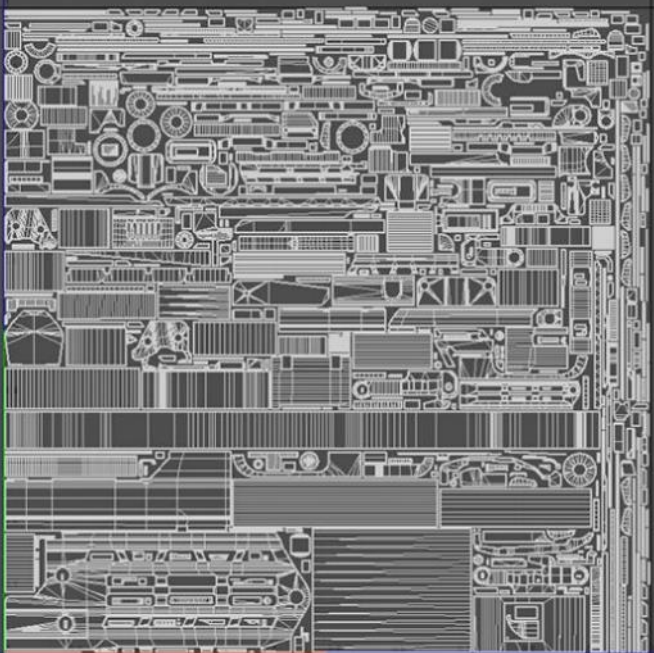

**Galil ace gen 2**  
UV



## Henry big boy

Tris - 40462

UV set – 2 (4096x4096)

Estimation – 30 days



**Henry big boy**  
Render



**Henry big boy**  
Render



# Henry big boy

Bake and Texturing



# Henry big boy

High Poly



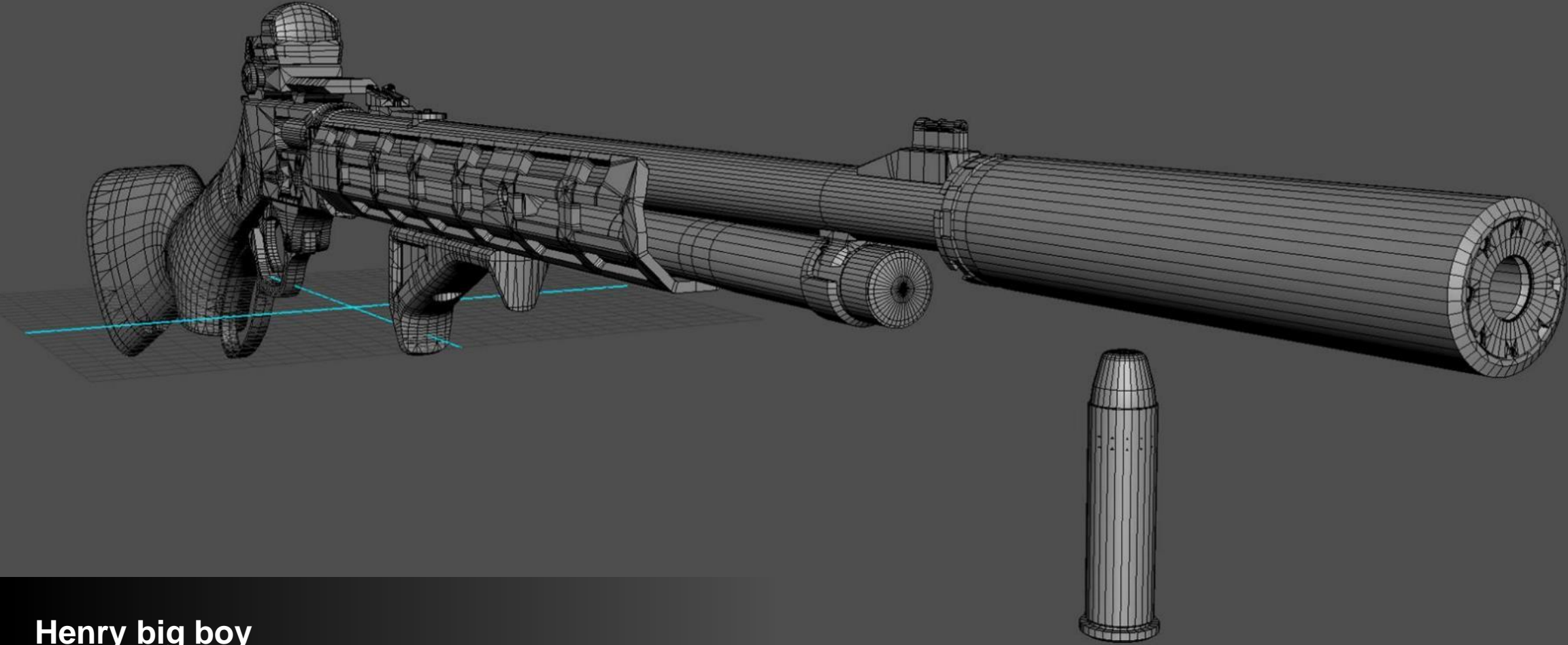

**Henry big boy**  
Low Poly

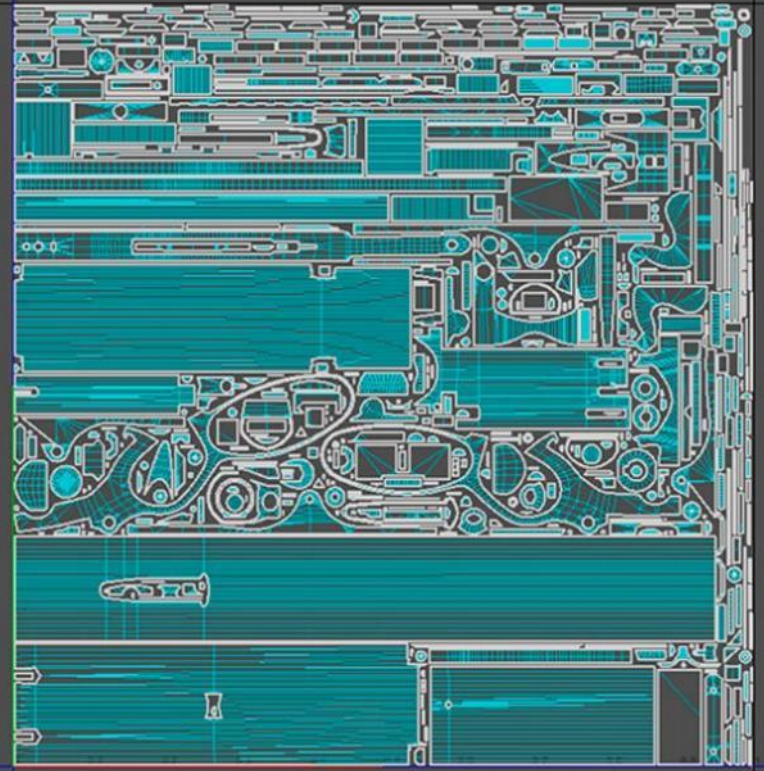
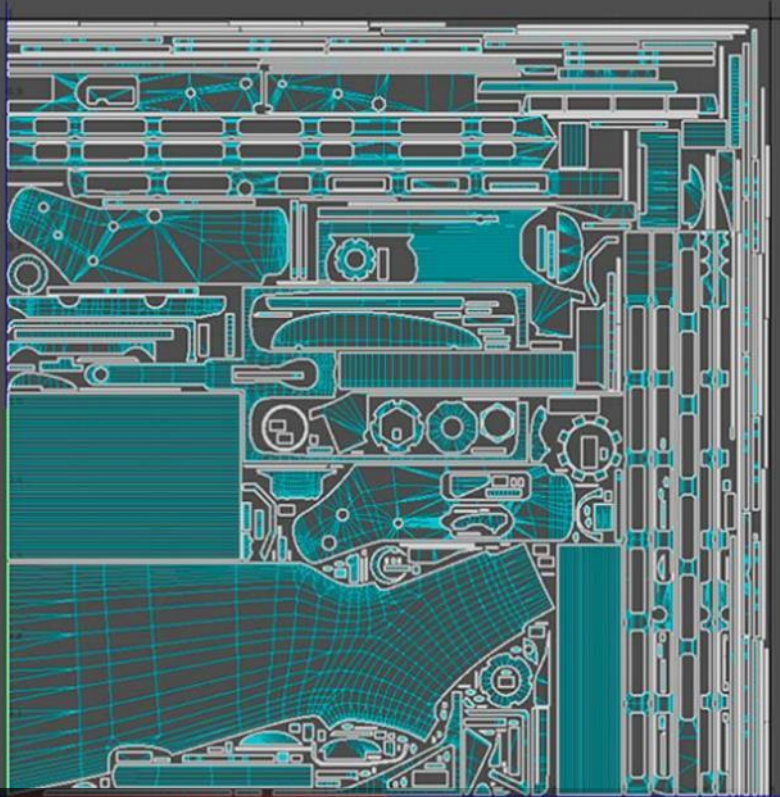

**Henry big boy**  
UV



### Kriss Vector

Tris - 69699

UV set – 9 (2048x2048)

Estimation – 35 days



# Kriss Vector

Render



# Kriss Vector

Render



**Kriss Vector**  
Bake and Texturing



**Kriss Vector**  
High Poly

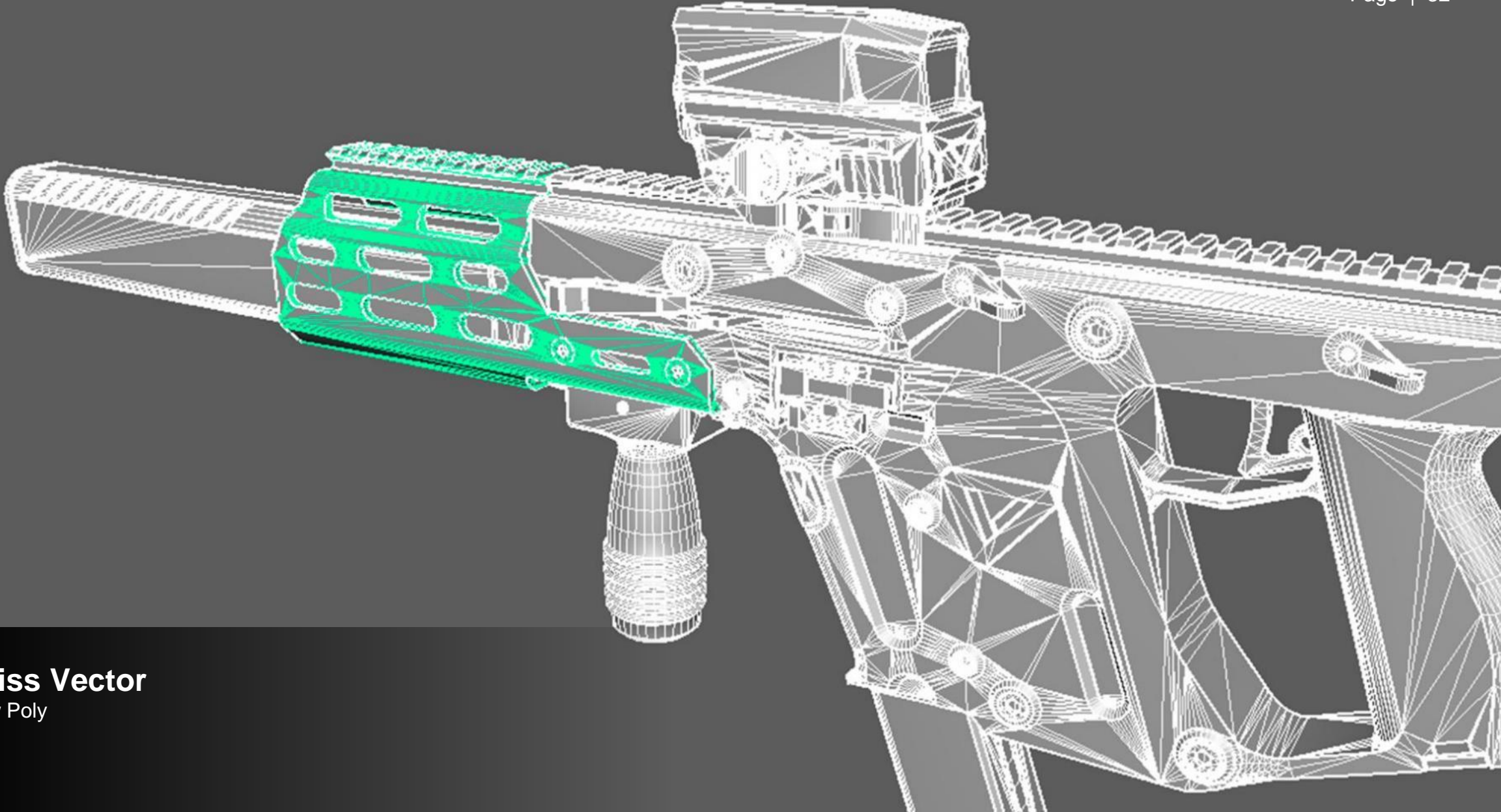

**Kriss Vector**  
Low Poly



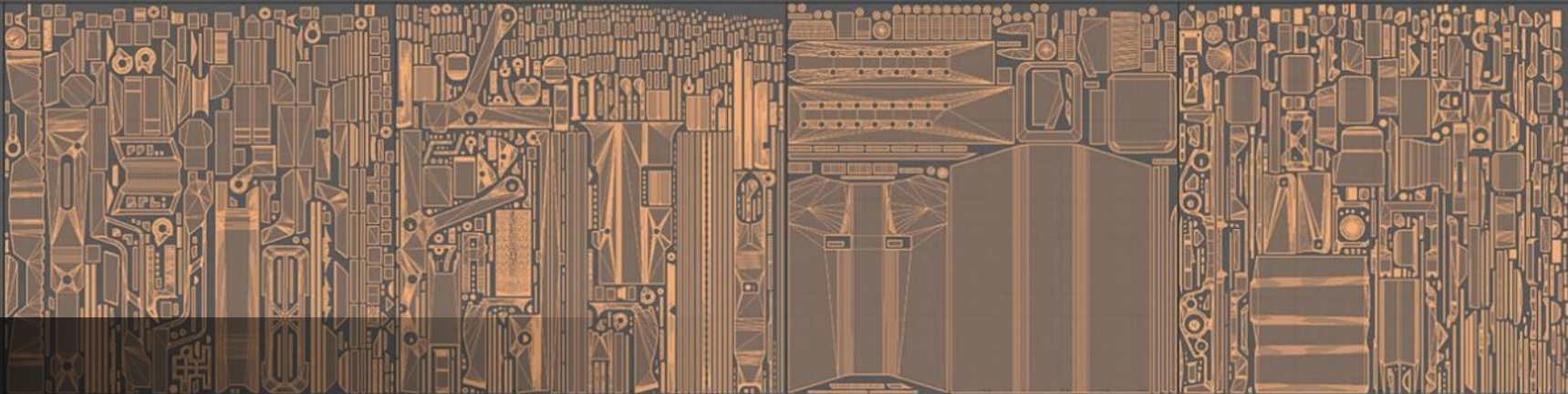
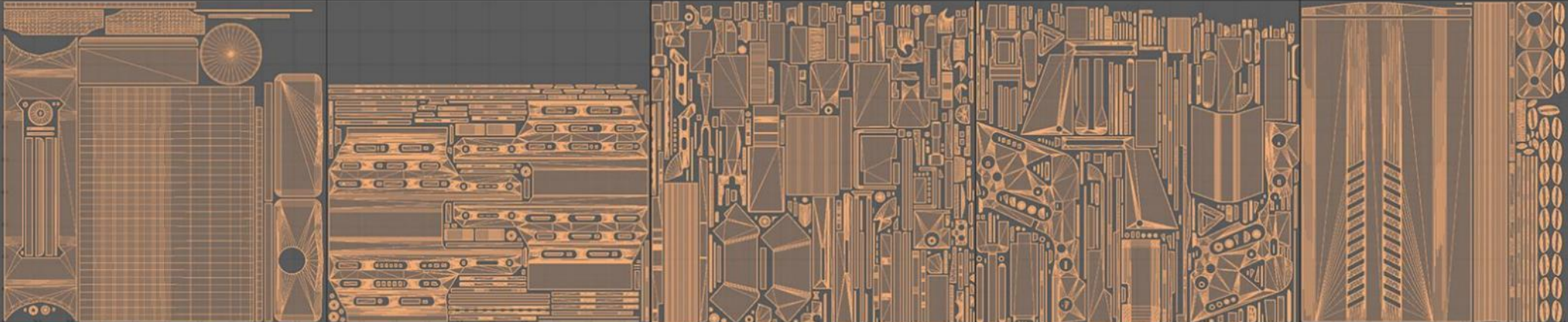

**Kriss Vector**  
UV



**Guavian**  
Render



# Guavian

High Poly  
Estimation – 10 days

PROPERTY OF ILMXLAB - USED WITH PERMISSION   





### Guavian

Low Poly  
 9 000 tris  
 Estimation – 6 days



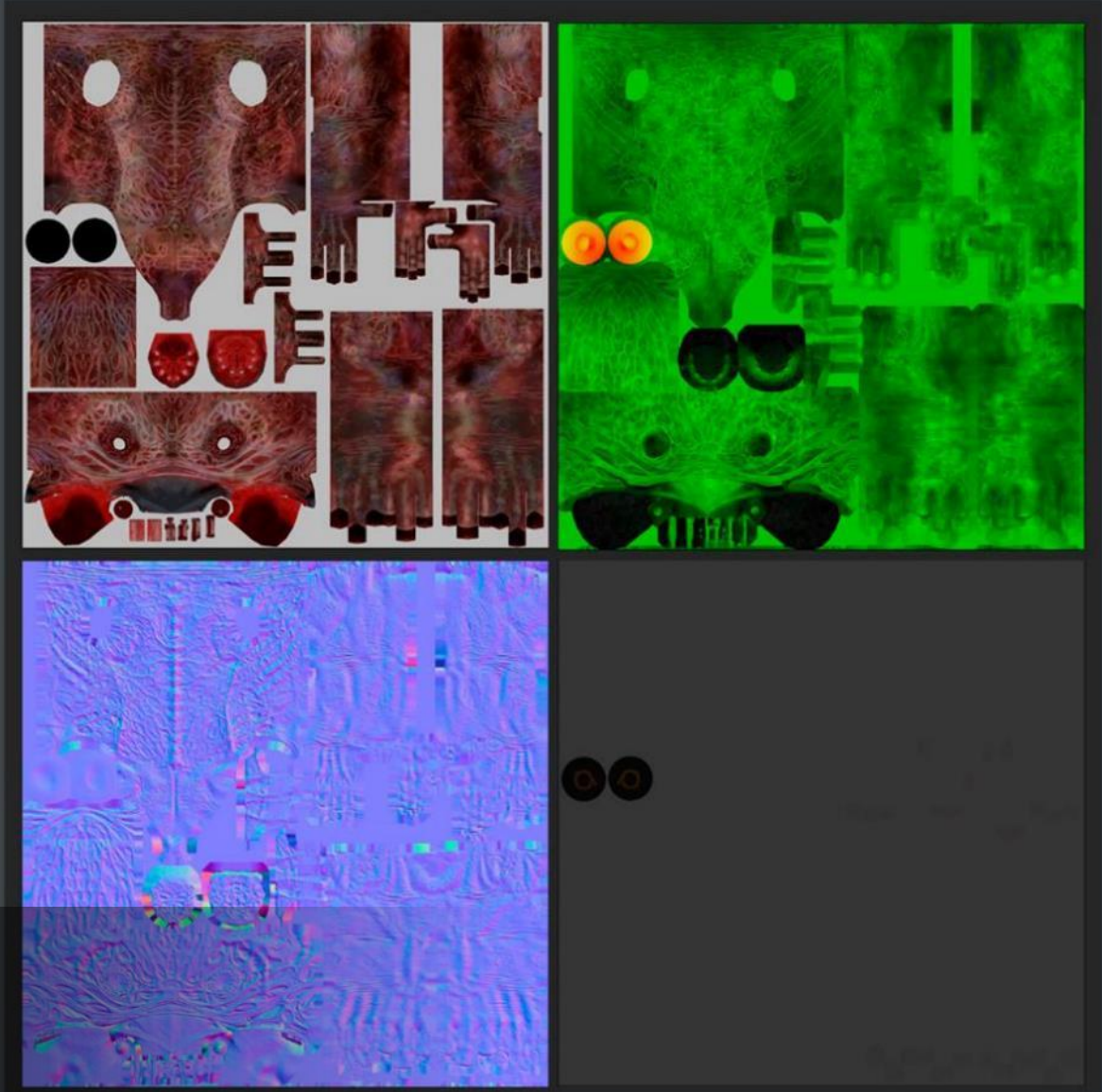

# Guavian

Textures  
Estimation – 5 days

# Guavian

High Poly  
Estimation – 10 days

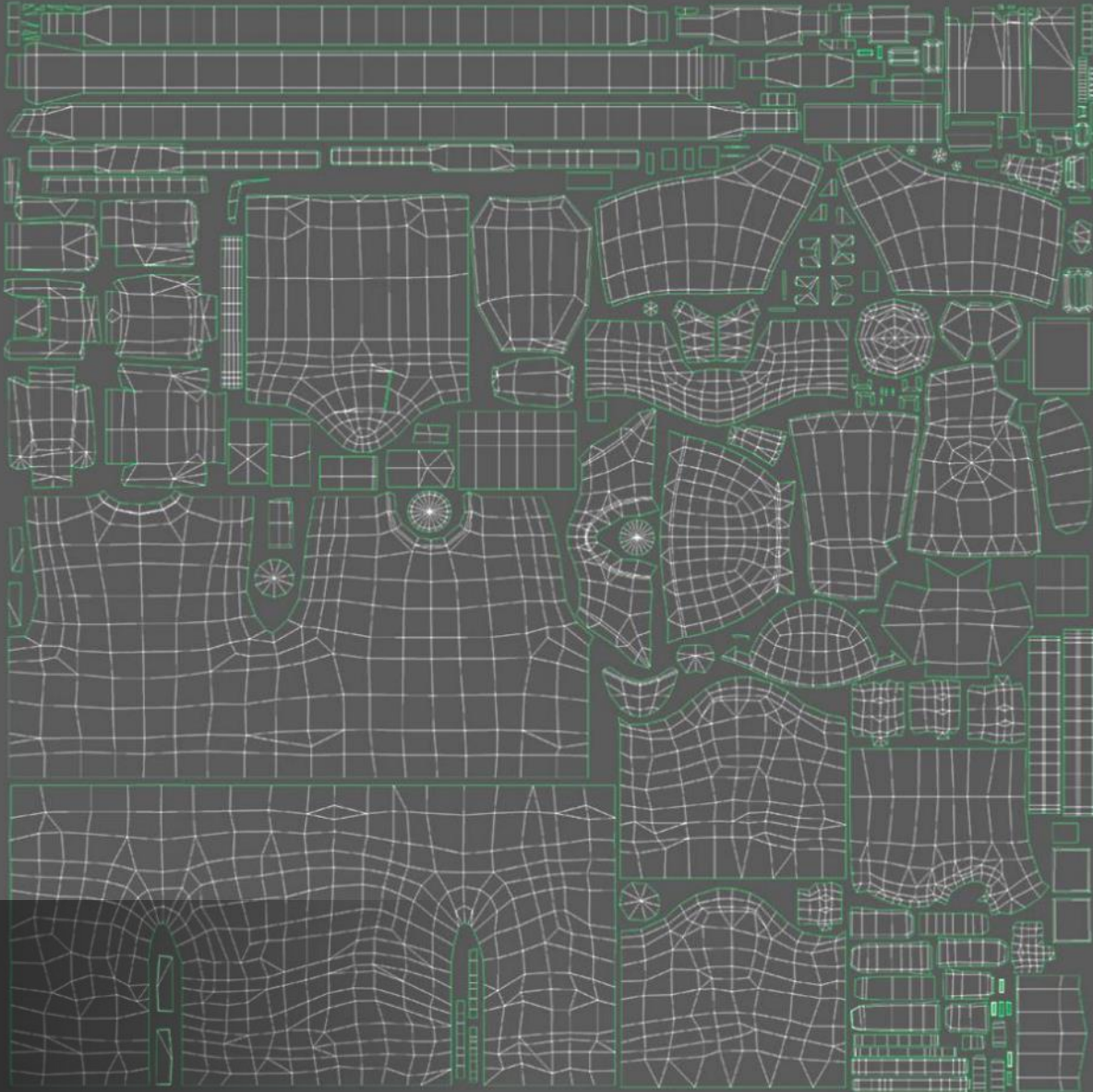

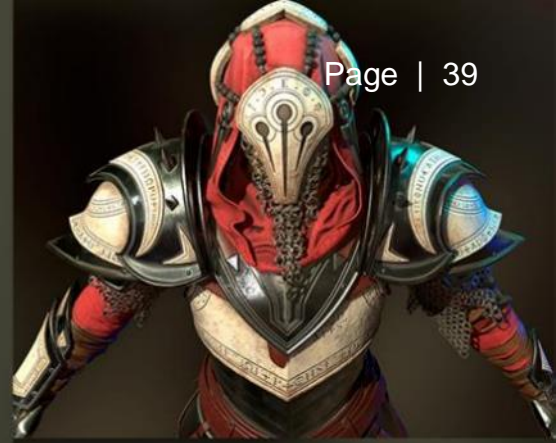

# Assasin

Final Render

Estimation – 2 days



# Assasin

High Poly  
Estimation - 18 days







# Assasin

Low Poly  
Estimation - 5 days



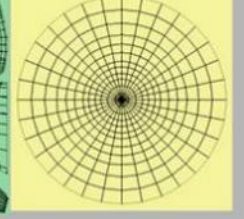
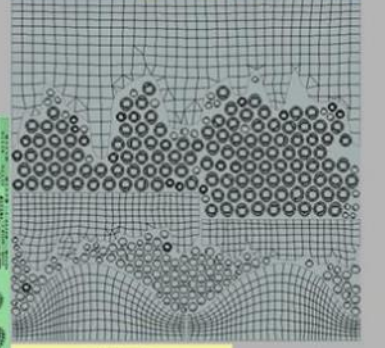
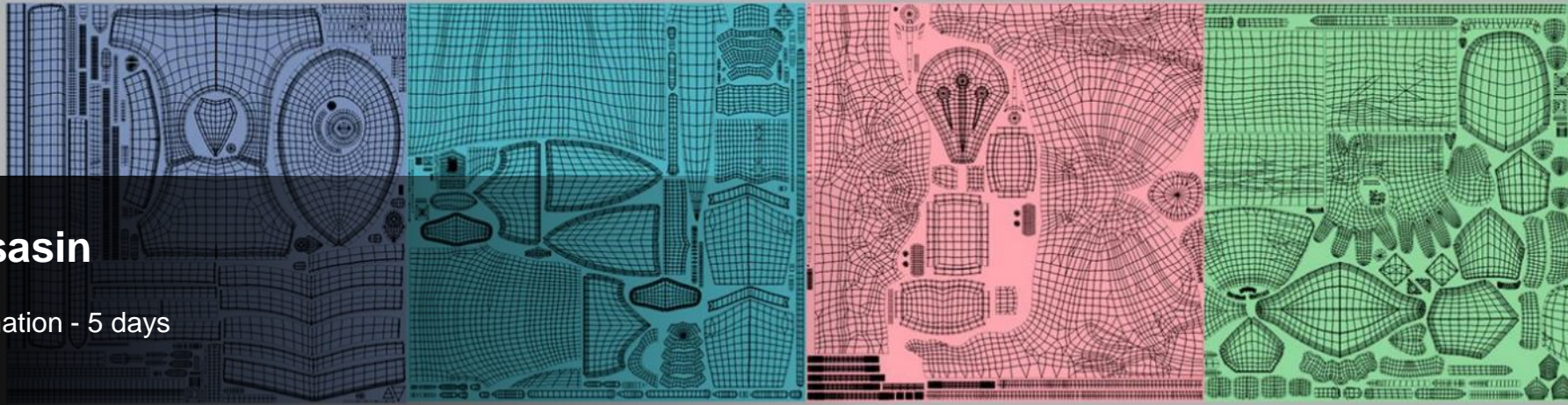
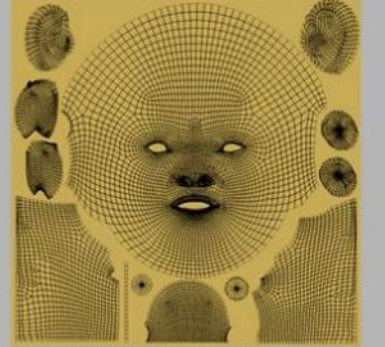
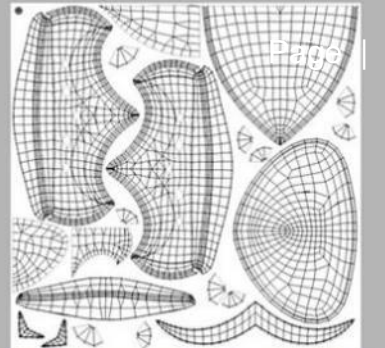

# Assasin

UVs  
Estimation - 5 days

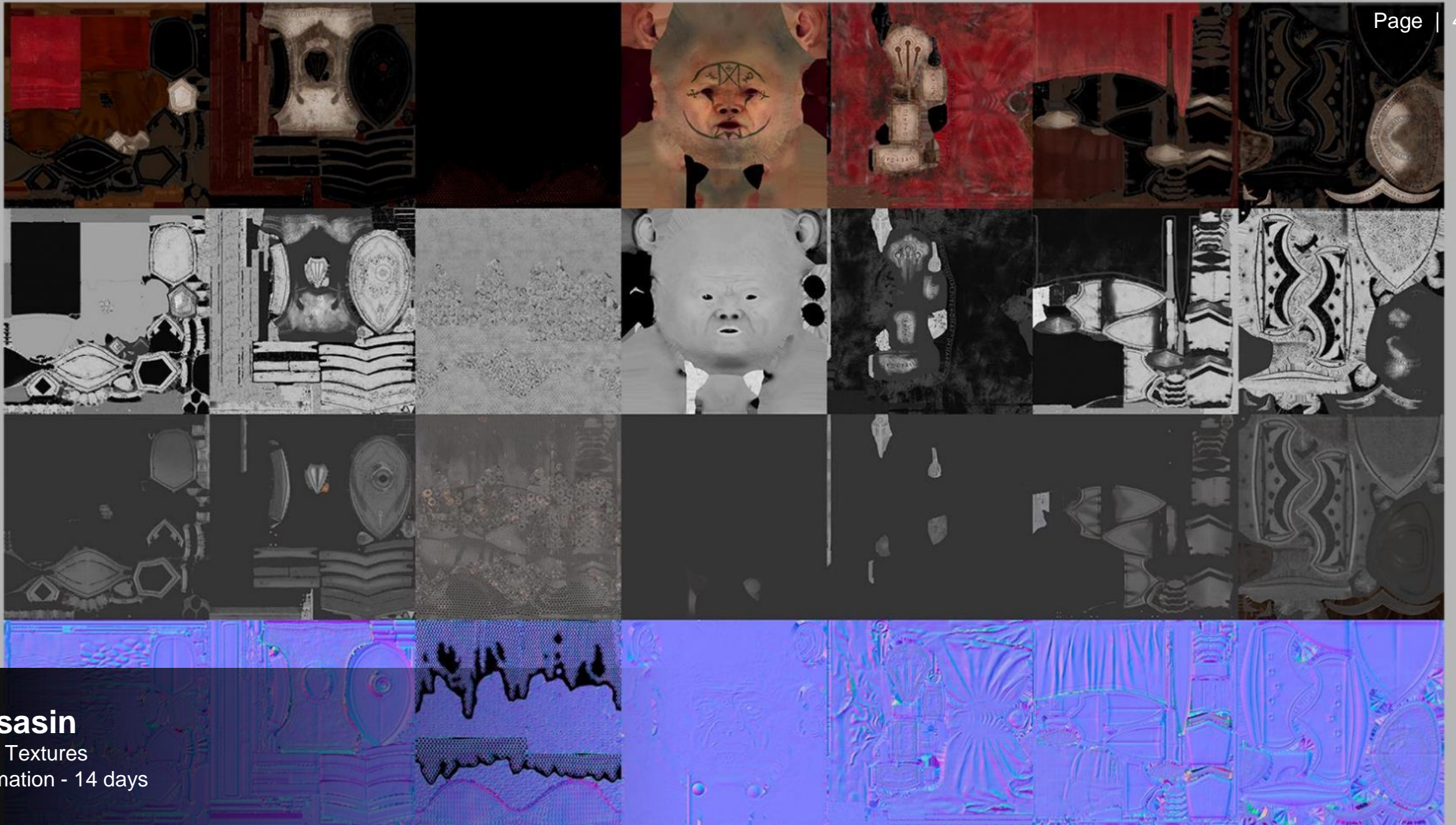

# Assasin

PBR Textures  
Estimation - 14 days



**Soldier**  
Render



**Soldier**

Head Texturing

Estimation – 5 days

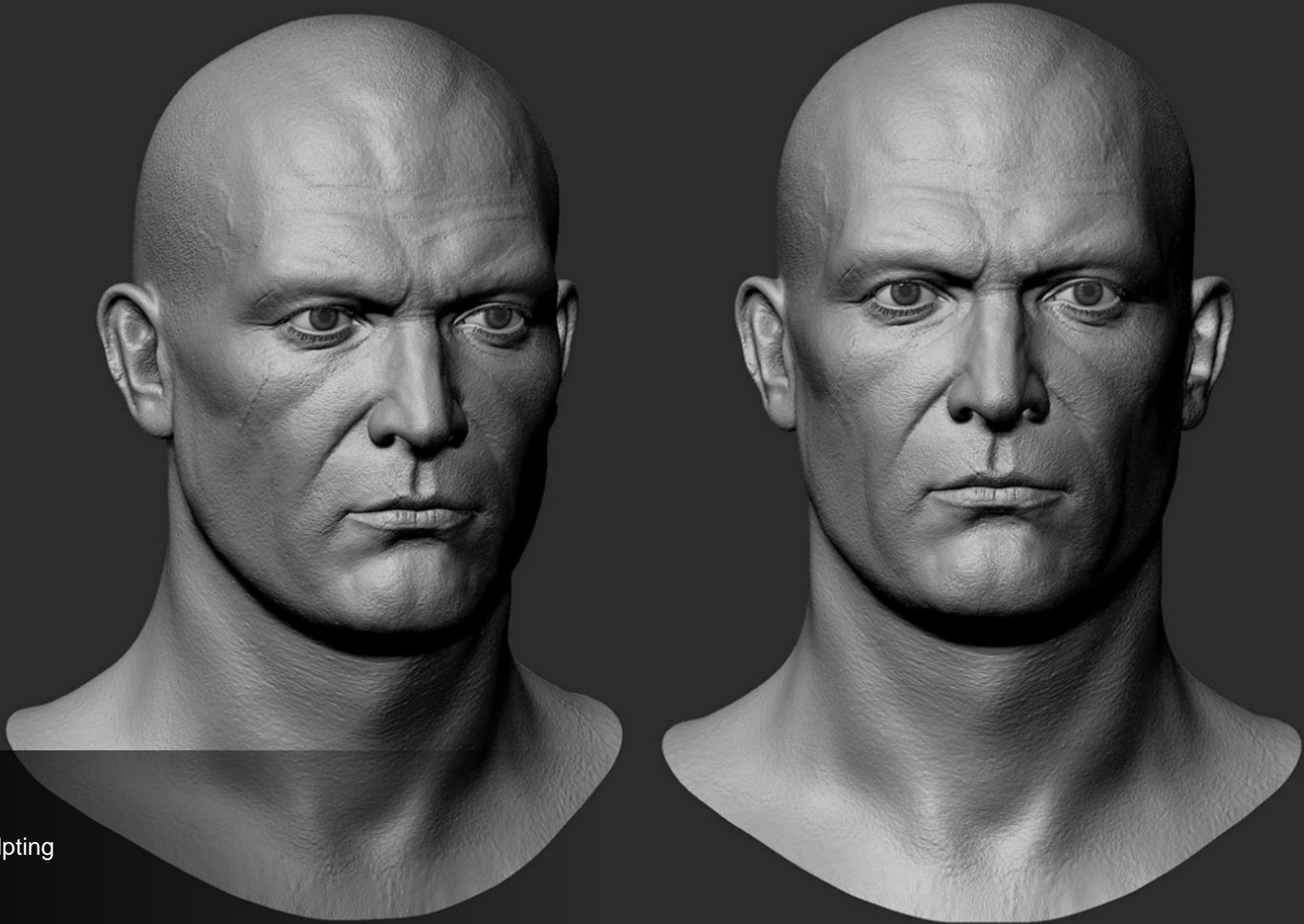

**Soldier**

High Poly Head Sculpting  
Estimation – 4 days



**Birdly**®

MADE FOR BIRDLY INSECTS BY SOMNIACS



**kevuru**  
games

**SOMNIACS**



MADE FOR BIRDLY INSECTS BY SOMNIACS



kevuru  
games

SOMNIACS







MADE FOR BIRDLY INSECTS BY SOMNIACS





**Helmet**  
Final Render



# Helmet

High Poly  
Estimation – 12 days





## Helmet

Low Poly  
18 000 tris  
Estimation – 8 days

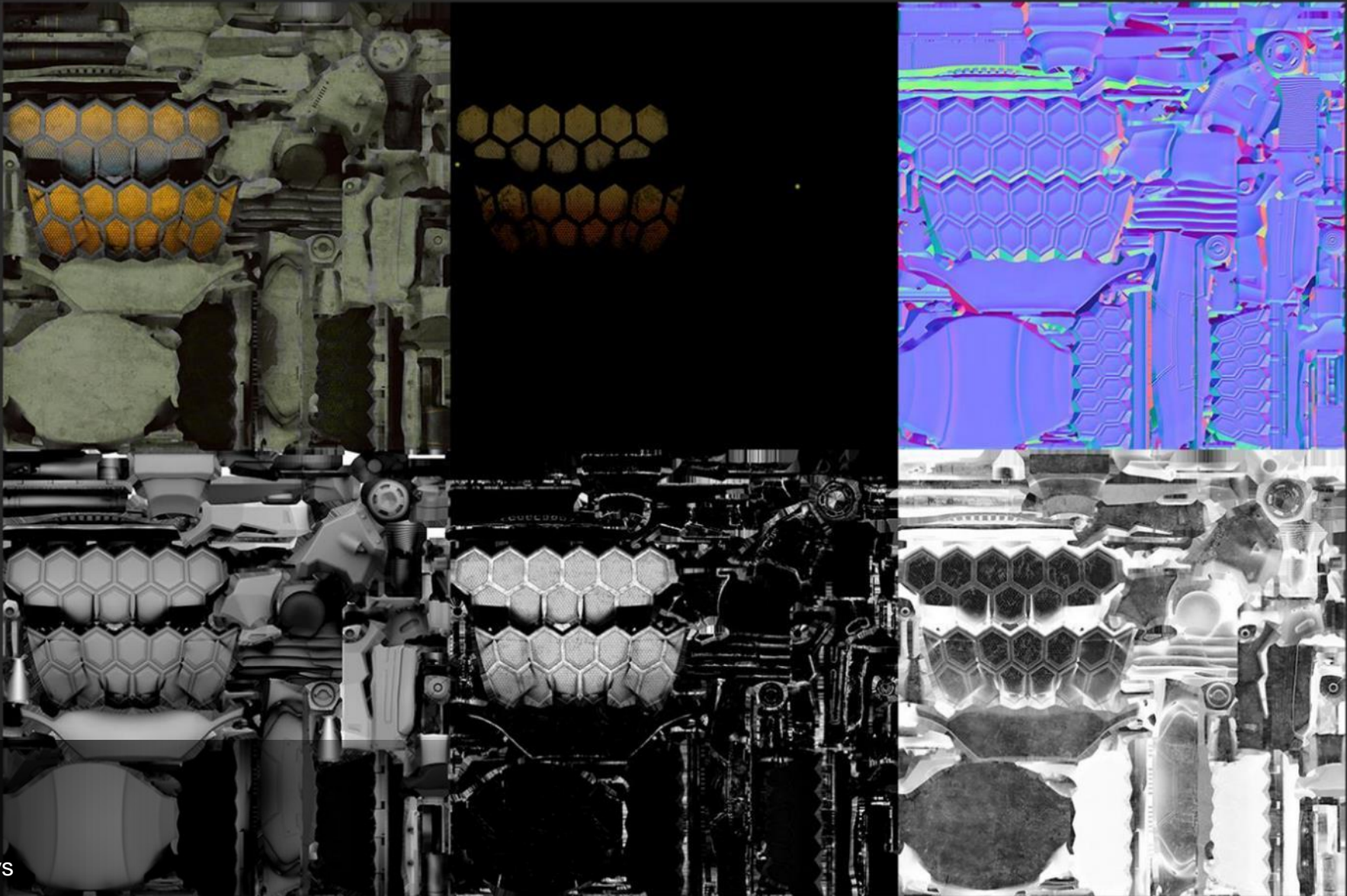

# Helmet

Textures  
Estimation – 8 days



# Helmet

UV  
Estimation – 4 days



### Kitchen set

5 500 tris  
2x 2k UV set  
Estimation – 4 days



### Wagon

20 000 tris  
1x 4k UV set  
Estimation – 5 days





# Sunflower

28 000 tris  
1x 2k UV set  
Estimation – 5 days



**Wooden set**

2 000 tris  
1x 4k UV set  
Estimation – 4 days











# CASUAL ART EXPERTISE











GUILD OF  
**GUARDIANS**



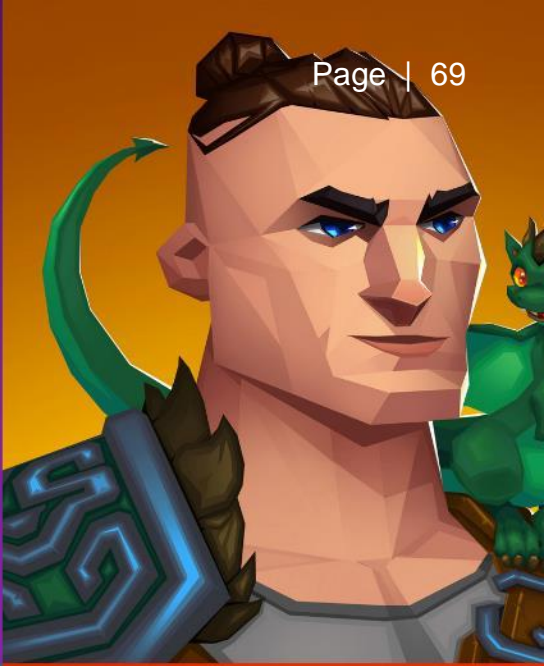

GUILD OF  
**GUARDIANS**









ART EXPERTISE

Illustrations





ART EXPERTISE

Illustrations





# Shroom

83.14%





Nickname

Level 46

2900



2900



Level 10

3

Nickname



Level 10

3

Nickname



37:47:13



37:47:13



30:00:30

Speed up

Level 10

3

Nickname



Level 20

37:47:13



Cage

16:21

Seeds

Special Offers

Potions

**NEW!**

## Potions Bundle

100500 Potions Pack



**\$10.00**

**NEW!**

## Potions Bundle

100500 Potions Pack

**\$10.00**  
~~\$15.00~~



x100 x6 x10 x6

**HOT!**

## Potions Bundle

100500 Potions Pack

**\$10.00**  
~~\$15.00~~





LINES 25	COIN VALUE 0,05	CASH BET \$ 1,50	MAX BET		WIN 7	BALANCE \$ 100000
-------------	--------------------	---------------------	---------	--	----------	----------------------

- 
- 
- 
- 
-

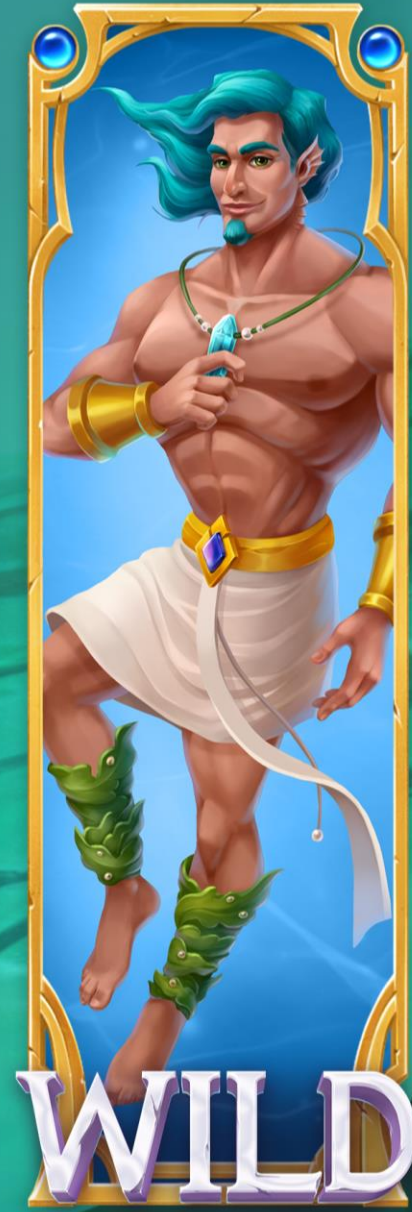



A K Q J IO





ART EXPERTISE

Environment























# CLIENTS REVIEWS



Our mission is to go an extra mile to deliver high-quality products with WOW effects and ensure maximum satisfaction for our customers. We have more than 50 partners worldwide and our clients are among of the top 10 world digital entertainment publishers.

**JAMES KUCERA, FORMER HEAD OF MOBILE DEVELOPMENT, BANDAI NAMCO AMERICA**



It was a pleasure working with Kevuru Games. They're very professional and understand the slot business very well. On top of that, they had good suggestions regarding the animations and art style, which we incorporated into our games. I will definitely work with them in the future.

**AMICHAH NAVEH MARMOR, GAMES DIRECTOR AT TECHONA**

**90%**

Clients are ready to recommend us

**3 years**

Average clients life

**40%**

Clients came on recommendations





# THANK YOU

## USA

📍 8, THE GREEN, STE R, Dover, DE 19901

☎ +1-424-413-5692

## UKRAINE

📍 Kozatska Street, 122/4, Kyiv, 03022

✉ [contact@kegurugames.com](mailto:contact@kegurugames.com)

☎ +380-98-067-14-98